

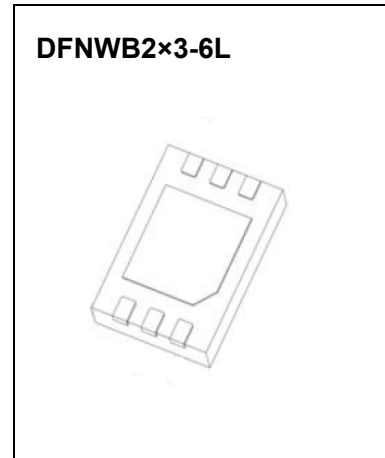

DFNWB2×3-6L Plastic-Encapsulate MOSFETS

CJCD2005 Dual N-Channel MOSFET



$V_{(BR)DSS}$	$R_{DS(on)TYP}$	I_D
20V	9 mΩ@4.5V	8A
	9.5mΩ@4.0V	
	9.7mΩ@3.8V	
	10.6mΩ@3.1V	
	12.5mΩ@2.5V	

DESCRIPTION

The CJCD2005 uses advanced trench technology to provide excellent $R_{DS(ON)}$ and low gate charge. It is ESD protected. This device is suitable for use as a uni-directional or bi-directional load switch, facilitated by its common-drain configuration.

MARKING:

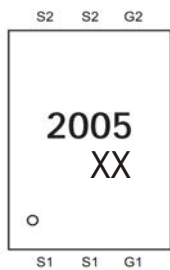

Top

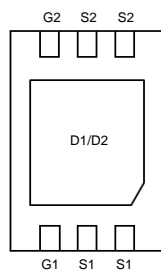

Back

2005 = Part No.
 Solid dot = Pin1 indicator.
 XX = Code.

Equivalent Circuit

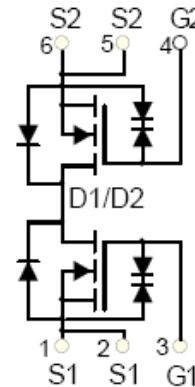

MAXIMUM RATINGS ($T_a=25^{\circ}C$ unless otherwise noted)

Parameter	Symbol	Value	Unit
Drain-Source Voltage	V_{DS}	20	V
Gate-Source Voltage	V_{GS}	±12	V
Continuous Drain Current	I_D	8	A
Pulsed Drain Current	I_{DM}^*	50	A
Thermal Resistance from Junction to Ambient	$R_{\theta JA}$	83.3	$^{\circ}C/W$
Junction Temperature	T_j	150	$^{\circ}C$
Storage Temperature	T_{stg}	-55~+150	$^{\circ}C$
Lead Temperature for Soldering Purposes(1/8" from case for 10 s)	T_L	260	$^{\circ}C$

MOSFET ELECTRICAL CHARACTERISTICS

$T_a=25\text{ }^\circ\text{C}$ unless otherwise specified

Parameter	Symbol	Test Condition	Min	Typ	Max	Unit
STATIC PARAMETERS						
Drain-source breakdown voltage	$V_{(BR)DSS}$	$V_{GS} = 0V, I_D = 250\mu A$	20			V
Zero gate voltage drain current	I_{DSS}	$V_{DS} = 16V, V_{GS} = 0V$			1	μA
Gate-body leakage current	I_{GSS}	$V_{GS} = \pm 4.5V, V_{DS} = 0V$			± 1	μA
		$V_{GS} = \pm 8V, V_{DS} = 0V$			± 10	μA
Gate threshold voltage (note 1)	$V_{GS(th)}$	$V_{bs} = V_{GS}, I_D = 250\mu A$	0.4		1	V
Drain-source on-resistance (note 1)	$R_{DS(on)}$	$V_{GS} = 4.5V, I_D = 3A$	7	9	12.0	m Ω
		$V_{GS} = 4.0V, I_D = 3A$	7.3	9.5	12.5	m Ω
		$V_{GS} = 3.8V, I_D = 3A$	7.5	9.7	13.0	m Ω
		$V_{GS} = 3.1V, I_D = 3A$	8.0	10.6	14.0	m Ω
		$V_{GS} = 2.5V, I_D = 3A$	9.5	12.5	15.0	m Ω
Forward transconductance (note 1)	g_{FS}	$V_{bs} = 5V, I_D = 7A$	9	36		S
Diode forward voltage(note 1)	V_{SD}	$I_S = 1A, V_{GS} = 0V$			1	V
DYNAMIC PARAMETERS (note 2)						
Input Capacitance	C_{iss}	$V_{DS} = 10V, V_{GS} = 0V, f = 1MHz$		1800		pF
Output Capacitance	C_{oss}			230		pF
Reverse Transfer Capacitance	C_{rss}			200		pF
Total gate charge	Q_g	$V_{DS} = 10V, V_{GS} = 4.5V, I_D = 7A$		17		nC
Gate-source charge	Q_{gs}			1.5		nC
Gate-drain charge	Q_{gd}			4.7		nC
SWITCHING PARAMETERS (note 2)						
Turn-on delay time	$t_{d(on)}$	$V_{GS} = 5V, V_{DD} = 10V,$ $R_L = 1.35\Omega, R_{GEN} = 3\Omega$		2.5		ns
Turn-on rise time	t_r			7.2		ns
Turn-off delay time	$t_{d(off)}$			49		ns
Turn-off fall time	t_f			108		ns
Drain-Source Diode Characteristics						
Diode Forward Current	I_S		-	-	6.0	A

Notes :

1. Pulse Test : Pulse width $\leq 300\mu s$, duty cycle $\leq 0.5\%$.
2. Guaranteed by design, not subject to production testing.

Typical Characteristics

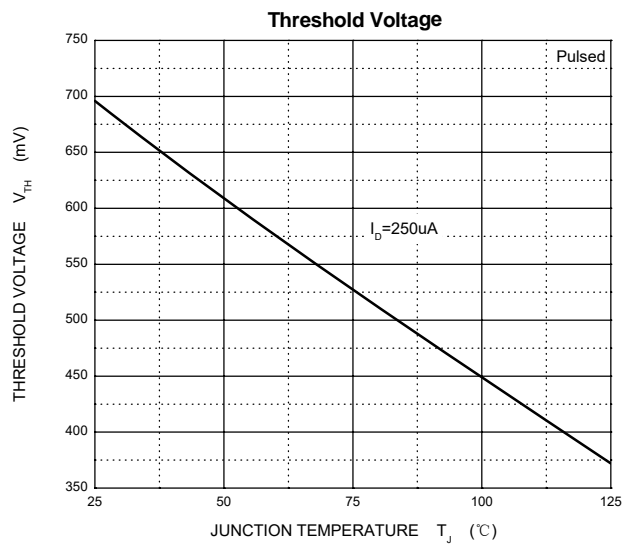
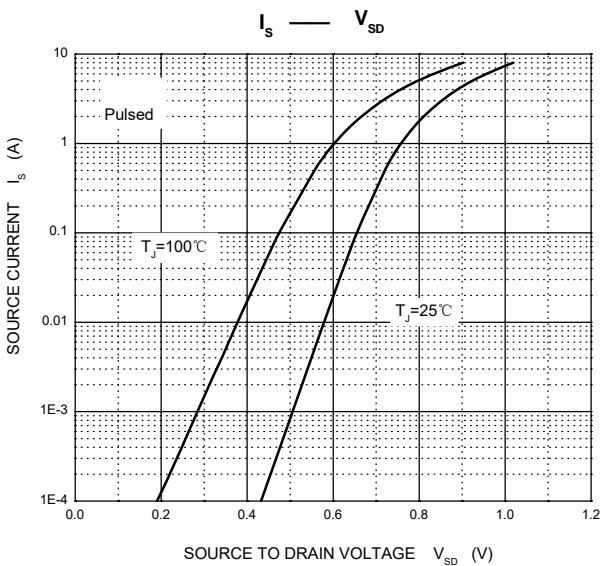
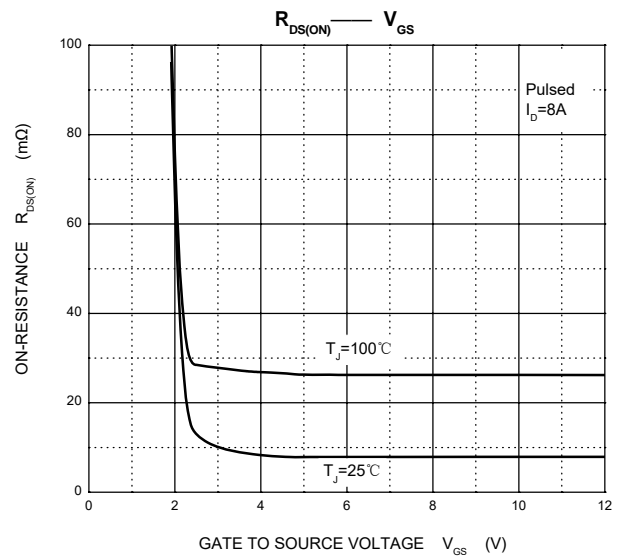
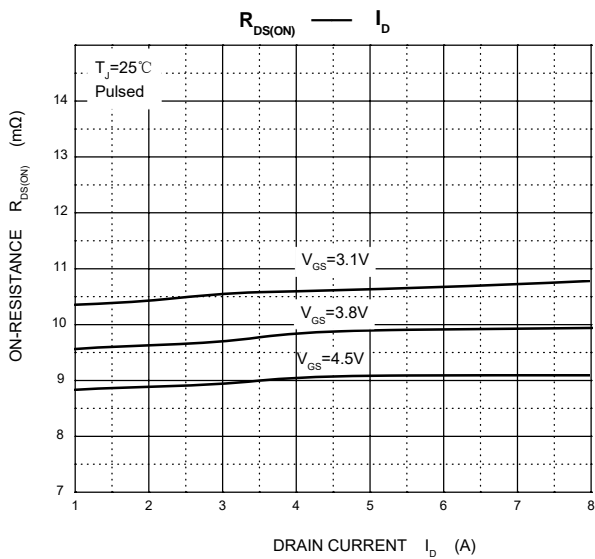
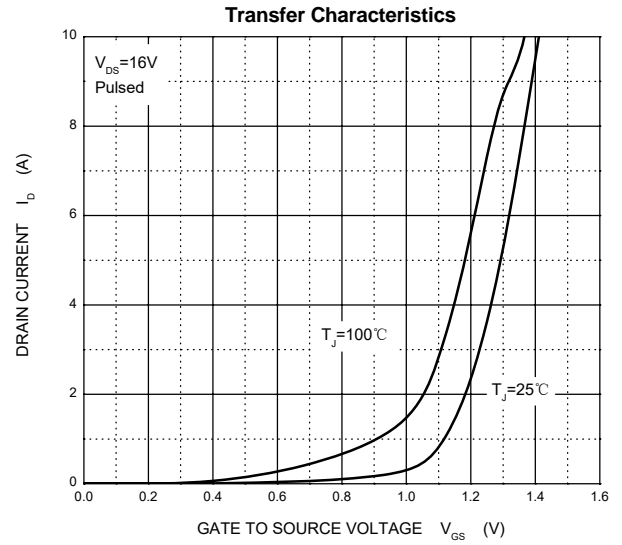
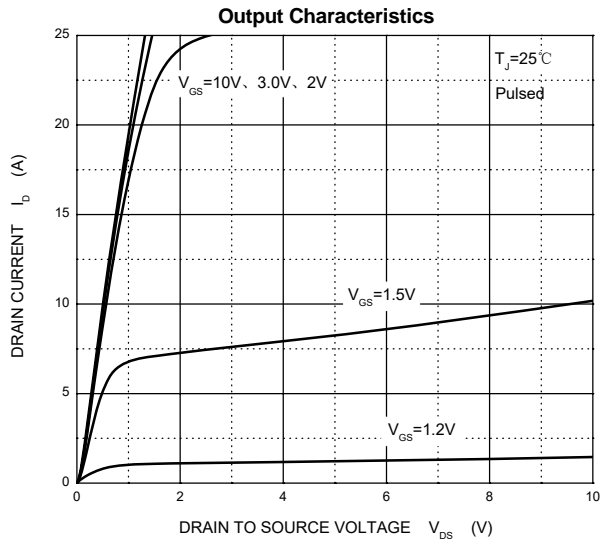

Typical Characteristics

TOTAL POWER DISSIPATION vs. AMBIENT TEMPERATURE

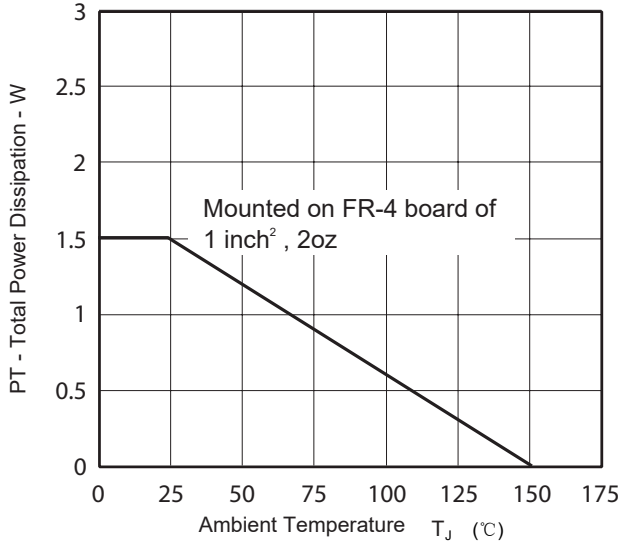

Maximum Safe Operating Area

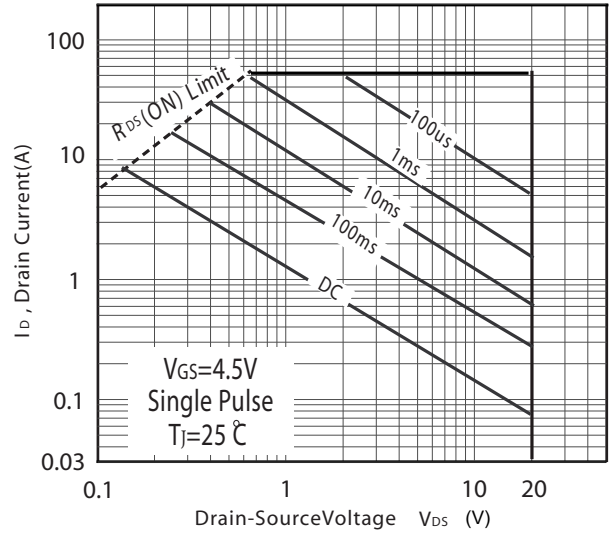

CJCD2005 $R_{DS(ON)}$ — T_A

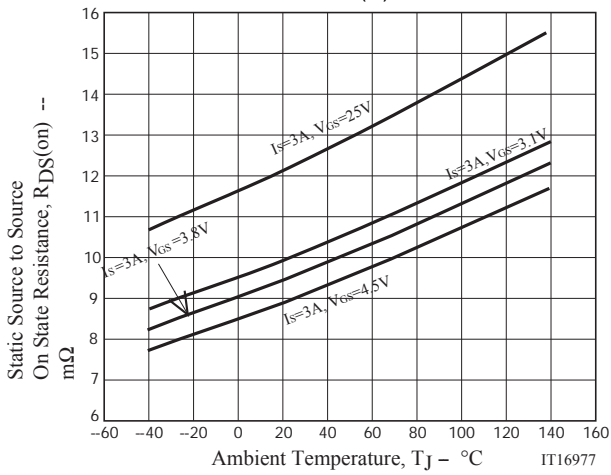

DFNWB2 × 3-6L Package Outline Dimensions(Unit:mm)

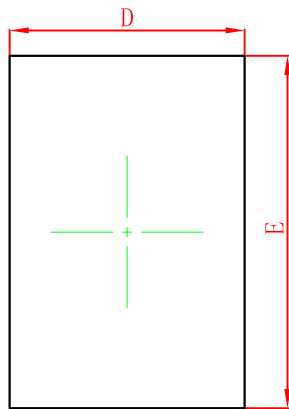

TOP VIEW

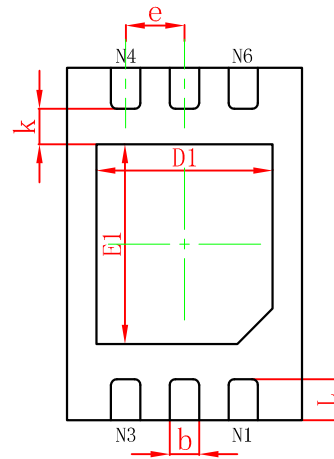

BOTTOM VIEW

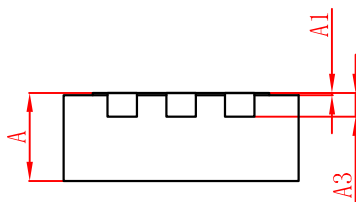

SIDE VIEW

Symbol	Dimensions In Millimeters		Dimensions In Inches	
	Min.	Max.	Min.	Max.
A	0.700	0.800	0.028	0.031
A1	0.000	0.050	0.000	0.002
A3	0.203REF.		0.008REF.	
D	1.950	2.050	0.077	0.081
E	2.950	3.050	0.116	0.120
D1	1.450	1.550	0.057	0.061
E1	1.650	1.750	0.065	0.069
k	0.200MIN.		0.008MIN.	
b	0.200	0.300	0.008	0.012
e	0.500TYP.		0.020TYP.	
L	0.300	0.400	0.012	0.016

DFNWB2 × 3-6L Suggested Pad Layout

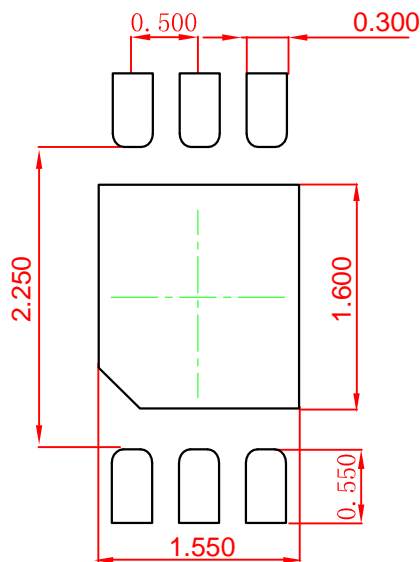

Note:

1. Controlling dimension: in millimeters.
2. General tolerance: ± 0.050 mm.
3. The pad layout is for reference purposes only.

NOTICE

JSCJ reserves the right to make modifications, enhancements, improvements, corrections or other changes without further notice to any product herein. JSCJ does not assume any liability arising out of the application or use of any product described herein.

DFNWB2X3-6L Tape and Reel

DFNWB2X3-6L Embossed Carrier Tape

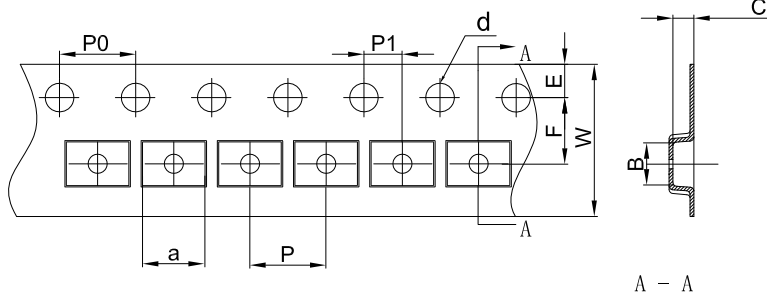

Packaging Description:

DFNWB2X3-6L parts are shipped in tape. The carrier tape is made from a dissipative (carbon filled) polycarbonate resin. The cover tape is a multilayer film (Heat Activated Adhesive in nature) primarily composed of polyester film, adhesive layer, sealant, and anti-static sprayed agent. These reeled parts in standard option are shipped with 3,000 units per 7" or 18.0cm diameter reel. The reels are clear in color and is made of polystyrene plastic (anti-static coated).

Dimensions are in millimeter

Pkg type	a	B	C	d	E	F	P0	P	P1	W
DFNWB2X3-6L	3.30	2.30	1.10	Ø1.50	1.75	3.50	4.00	4.00	2.00	8.00

DFNWB2X3-6L Tape Leader and Trailer

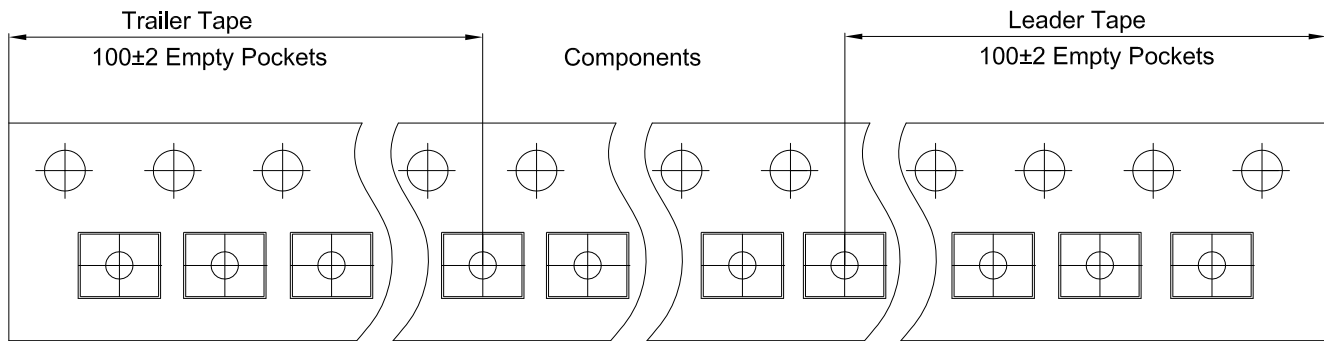

DFNWB2X3-6L Reel

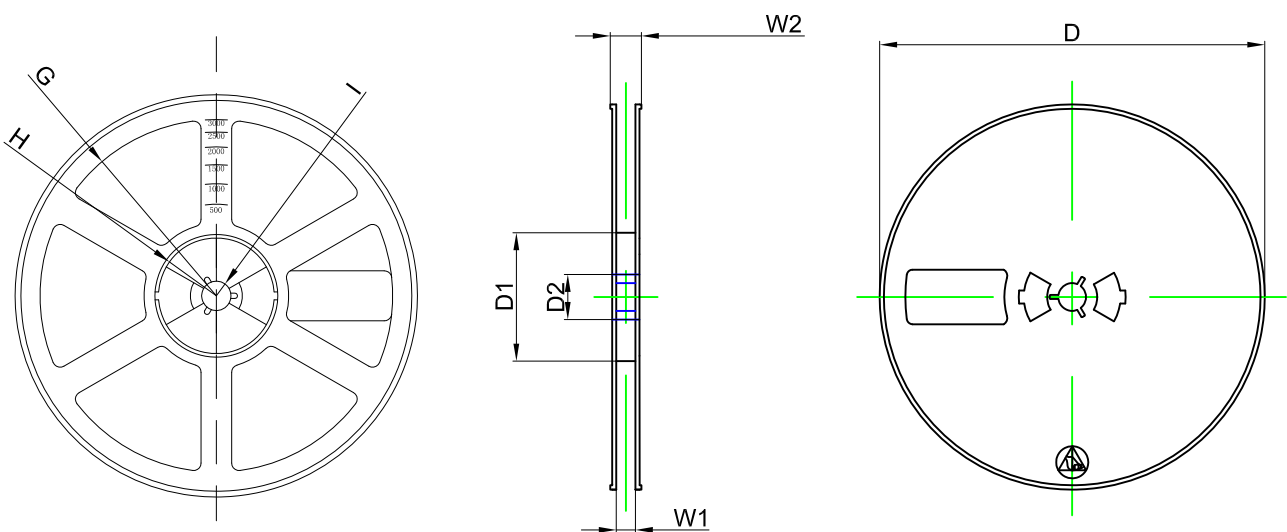

Dimensions are in millimeter

Reel Option	D	D1	D2	G	H	I	W1	W2
7" Dia	Ø180.00	60.00	13.00	R78.00	R25.60	R6.50	9.50	13.10

REEL	Reel Size	Box	Box Size(mm)	Carton	Carton Size(mm)	G.W.(kg)
3000 pcs	7 inch	30,000 pcs	203×203×195	120,000 pcs	438×438×220	